



PRODUCT DATA SHEET

Laser Diode (TO-3 package)

Model FB-M1470-2000TO3

Specification	Symbol	Typical	Unit
Laser Emitter			
Peak Wavelength	λ_{op}	1470±10	nm
CW Optical Output Power	P_{op}	2	W
Operation Current	I_{op}	<6	A
Operation Voltage	U_{ld}	1.15±0.1	V
Threshold Current	I_{th}	<0.9	A
Beam Divergence (FWHM)	$\theta_{ }$	14±2	degree
Beam Divergence (FWHM)	θ_{\perp}	1±0.3	degree
Spectrum Half-Width (FWHM)	$\Delta\lambda$	<8	nm
Emitting Area	$W \times d$	100x1	$\mu m \times \mu m$
Operation Mode	-	CW, QCW, Pulse ($\tau > 5ns$)	-
Operation Temperature	Top	25	degree
Photo Diode Monitor			
PD Monitor Current		1-1000	μA
PD Reverse Voltage		9	V
Wavelength Temperature Coefficient	$\Delta\lambda/\Delta T$	3±0.2	$\text{\AA}/\text{degree}$
Operation Current Temperature Coefficient	$\Delta I/\Delta T$	15±5	mA/degree
Operation Temperature Range		-20... +40	degree
Storage Temperature Range		-40... +80	degree



Drawings:

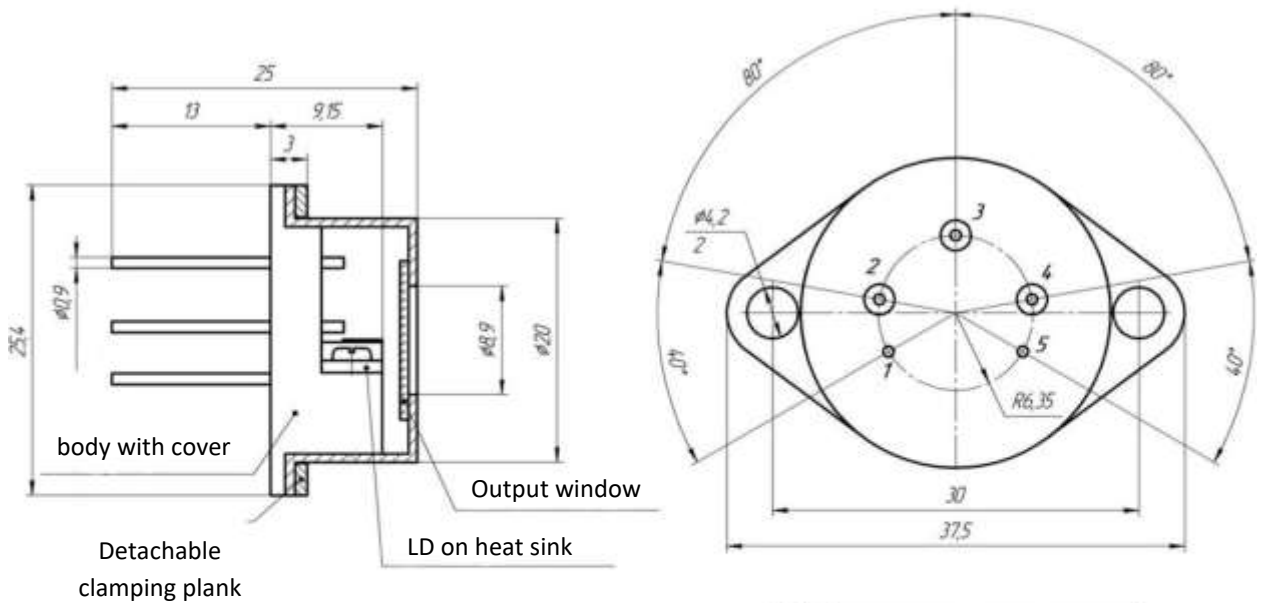

Detachable clamping plank

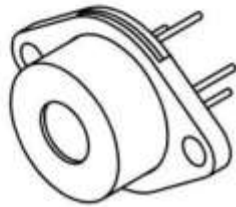

1	«+» Laser
2	«-» Laser
3	PD monitor
4	«-» Laser
5	«+» laser