

## PRODUCT DATA SHEET

Laser Diode (HHL w/fiber package)

Model FB-M1800-200HF

Specification	Symbol	Typical	Unit
Laser Emitter (at Top=25 degree)			
Peak Wavelength	$\lambda_{op}$	1800±20	nm
CW Optical Output Power	$P_{op}$	0.15	W
Operation Current	$I_{op}$	<2	A
Operation Voltage	$U_{ld}$	1.05±0.1	V
Threshold Current	$I_{th}$	<1	A
Spectrum Half-Width (FWHM)	$\Delta\lambda$	<7	nm
Operation Mode		Continuous	-
Optical Fiber			
Fiber diameter		100 or 200	μm
Coating diameter		125 or 220	μm
Outer diameter		3	mm
Numerical Aperture		0,22	-
Fiber Length		1	m
Optical Connector Type		FC	-
Photo Diode Monitor			
PD Monitor Current		1-1000	μA
PD Reverse Voltage		9	V
TEC			
Maximum Current		5	A
Maximum Operation Voltage		3,8	V
Other parameters			
Thermistor Resistance		10	kilohm
Operation Temperature Range		-20... +40	degree
Wavelength Temperature Coefficient	$\Delta\lambda/\Delta T$	3±0.2	Å/degree
Operation Current Temperature Coefficient	$\Delta I/\Delta T$	15±5	mA/degree
Guaranteed Life Time		1	year



*Thermistor resistance diagram*

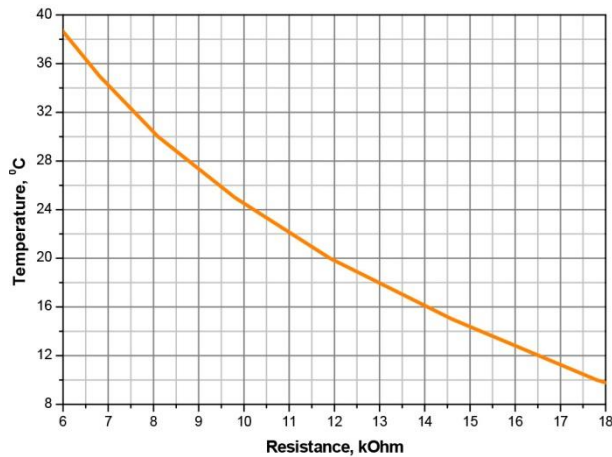

*Dimensions and pinouts*

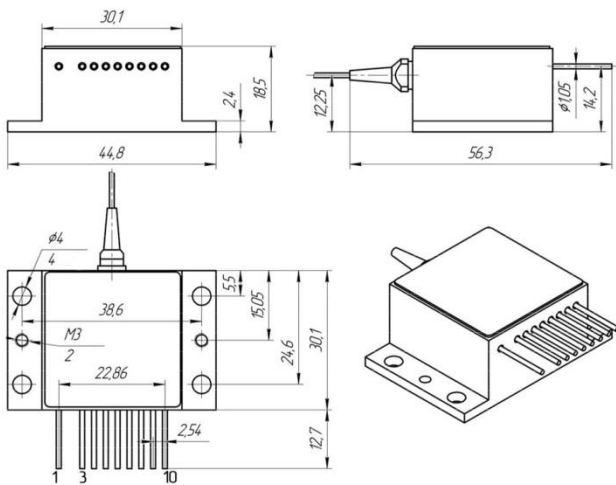

- 1-TEC (-)
- 2-
- 3-
- 4- Laser Anode(+)
- 5- Thermistor (2)
- 6- Thermistor (1)
- 7- Laser Cathode (-)
- 8- PD Anode (+)
- 9- PD Cathode (-)
- 10- TEC (+)