



## PRODUCT DATA SHEET

Laser Diode (TO-3 package)

Model FB-M1060-3000TO3

Specification	Symbol	Typical	Unit
Laser Emitter			
Peak Wavelength	$\lambda_{op}$	1060±20	nm
CW Optical Output Power	$P_{op}$	3	W
Operation Current	$I_{op}$	<5	A
Operation Voltage	$U_{ld}$	1.5±0.2	V
Threshold Current	$I_{th}$	< 0.6	A
Beam Divergence (FWHM)	$\theta_{  }$	8±2	degree
Beam Divergence (FWHM)	$\theta_{\perp}$	1	degree
Spectrum Half-Width (FWHM)	$\Delta\lambda$	< 3.5	nm
Emitting Area	$W \times d$	100x1	$\mu\text{m} \times \mu\text{m}$
Operation Mode	-	CW, QCW, Pulse ( $\tau > 5\text{ns}$ )	-
Operation Temperature	Top	25	degree
Photo Diode Monitor			
PD Monitor Current		1-1000	$\mu\text{A}$
PD Reverse Voltage		9	V
Wavelength Temperature Coefficient	$\Delta\lambda/\Delta T$	3±0.2	$\text{\AA}/\text{degree}$
Operation Temperature Range		-20... +40	degree
Storage Temperature Range		-40... +80	degree



Drawings:

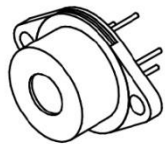
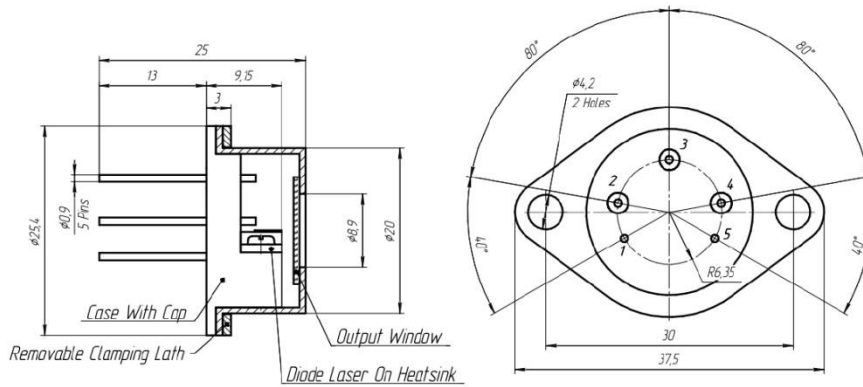

1, 5	LD +
2	PD +
3	PD -
4	LD -